



■ GEBERIT

GEBERIT AQUACLEAN TUMA COMFORT

---

# ENGINEER FULL OPERATION GUIDE

---

# CONTENTS

<b>For your safety .....</b>	<b>5</b>
Who is this product suitable for? .....	5
How is this product used? .....	5
What should you avoid? .....	5
Misuse .....	5
General safety notes .....	6
Explanation of warning notes .....	7
Overview of symbols on the product .....	8
<b>Register your device .....</b>	<b>9</b>
<b>Getting to know your device .....</b>	<b>10</b>
About Geberit AquaClean devices .....	10
Functional overview.....	10
The device at a glance .....	11
<b>Operating concept.....</b>	<b>13</b>
About the operating concept .....	13
Front side of the remote control .....	13
Rear side of the remote control .....	14
Lateral control panel.....	14
Status LED on the lateral control panel.....	15
Geberit AquaClean app.....	16
Special assignment of the buttons .....	17
Switching the device on and off.....	19
<b>How to use the device .....</b>	<b>21</b>
Getting started.....	21
Switch functions on or off permanently .....	22
Your device settings.....	23
Additional device settings in the Geberit AquaClean app .....	23
Use the anal shower.....	24
Adjusting the shower procedure to your personal needs .....	24
Switching the oscillating motion of the anal shower on and off.....	24
Use the Lady shower.....	25
Switching the oscillating motion of the Lady shower on and off.....	25
Switch dryer on and off.....	26
Switch off WC seat ring heating .....	26
Switch odour extraction run-on function on and off.....	27
Switch continuous flow heater off and on.....	27
<b>Adjusting the shower procedure to your personal needs .....</b>	<b>28</b>
Set the spray intensity .....	28
Set the spray arm position.....	28
Change basic profile.....	29
Save user profiles.....	29
Calling up user profiles.....	30
Saving your personal user profile in the Geberit AquaClean app .....	30
<b>Cleaning and descaling the device .....</b>	<b>31</b>
General cleaning recommendations.....	31

Suitable cleaning agents and cleaning equipment.....	31
Automatic water replacement.....	33
Targeted disinfection.....	33
Caring for and cleaning smooth surfaces.....	33
Cleaning coated WC ceramic appliances.....	33
Cleaning the flushing area of the WC ceramic appliance.....	34
Removing the WC lid.....	34
Cleaning the WC lid, WC seat ring and housing.....	35
Cleaning between the device and the WC ceramic appliance.....	36
Clean the spray nozzle.....	37
Replace the ceramic honeycomb filter.....	38
Descale the device.....	40
Device descaling message.....	42
<b>Troubleshooting.....</b>	<b>43</b>
Troubleshooting.....	43
The shower toilet is without function.....	44
Other functional errors.....	45
The remote control is without function.....	47
Replace the remote control battery.....	48
Re-assign remote control.....	49
<b>Sustainability.....</b>	<b>50</b>
Geberit Group and sustainability.....	50
Ecodesign – ecobalance.....	50
Tips for reducing the ecological footprint.....	50
<b>Disposal.....</b>	<b>51</b>
Disposal of old electrical and electronic equipment.....	51
<b>End user warranty.....</b>	<b>52</b>
End user warranty.....	52
<b>Technical data and conformity.....</b>	<b>53</b>
Technical data.....	53
Simplified EU Declaration of Conformity.....	53

## For your safety

---

### Who is this product suitable for?

As a functioning toilet, the Geberit AquaClean shower toilet is suitable for all age groups. However, children must not carry out cleaning or maintenance work without supervision.

### How is this product used?

The product is suitable for the following application purposes and areas of use:

- as a shower toilet:
  - for cleaning the anal area
  - for cleaning the outer vaginal area
  - for odour extraction
- for installation in heated indoor areas
- for connection to the drinking water system
- for operation with water from reverse osmosis systems

### What should you avoid?

The product must be used as intended. Do not:

- leave the WC seat ring during the shower procedure
- place loads or objects on the WC lid
- immerse the remote control in liquid
- operate without plug for Geberit AquaClean descaling agent

### Misuse

Geberit accepts no liability for the consequences arising from misuse.

## General safety notes

The following safety notes apply for the entire duration of the product's life cycle:

- Read the user manual before the first use to familiarise yourself with the use of the product.
- Store the user manual for future reference.
- Impurities in the filter could lead to contamination of the breathing air. In order to preclude any health risks and ensure proper functioning, the filter must be replaced annually.
- Do not use the device if it is damaged. If possible, isolate the device from the supply system and contact Geberit customer service.
- Do not open the device. It does not contain any components for the user to service or repair.
- Do not perform any changes or additional installations. Modifying the device runs the risk of fatal danger.
- Repairs may only be carried out by authorised skilled persons using original spare parts.
- Only original accessories may be used.
- Operation and maintenance work may only be performed by the operator or user as described in this user manual.
- Always use the current version of the installation manual for installing the device if the Geberit AquaClean has been removed (e.g. if you move house).
- The Geberit AquaClean must only be connected to a mains voltage conforming to the specification plate.
- Observe the manufacturer information at all times regarding the use of cleaning and descaling agents.

---

 This document contains warning notes at various points. Warning notes are usage and situation-specific safety notes. They provide warnings on specific hazards.

---

 These instructions correspond to the state of the device technology at the time of printing. Geberit reserves the right to make changes in terms of further development.

A current version of this and other documents is available online: [www.geberit.com](http://www.geberit.com).

## Explanation of warning notes

Warning notes are placed at the location at which the hazard may occur.

Warning notes are structured as follows:





### **WARNING**

#### **Nature and source of the hazard**



Possible consequences if the hazard is ignored.

- ▶ Measures to prevent the hazard.

The following signal words are used to indicate residual hazards in warning notes and important information.

Symbol	Signal word and meaning
	<b>DANGER</b> The signal word denotes a hazard with a high degree of risk which, if not avoided, will result in death or serious injury.
	<b>CAUTION</b> The signal word denotes a hazard with a low degree of risk which, if not avoided, could result in minor or moderate injury.
	<b>ATTENTION</b> The signal word denotes a hazard, which, if not avoided, may result in material damage.
	Symbol only. Refers to important information

**Overview of symbols on the product**

Symbol	Meaning
	Read the safety notes and operating instructions/ operation manual before commissioning the product.
	Danger of fatal electric shock

**Register your device**

**Warranty registration**

Extend the warranty period of your Geberit AquaClean for free. Register for this within 90 working days from the installation date.



In the third year of the warranty period, Geberit shall supply spare parts free of charge in the event of any material or manufacturing faults, provided the product has been installed and put into operation by an installation company.

By computer: <http://www.geberit-aquaclean.com/registration>

By post: Fill out the warranty card supplied and send it to us.

By smartphone or tablet:



Android:



iOS:



Via the Geberit AquaClean app:

## Getting to know your device

### About Geberit AquaClean devices

The Geberit AquaClean device is a WC with integrated shower function. The device fulfils all the functions of a conventional toilet. Additional functions are subject to the design of your product.

### Functional overview

Hygiene functions:

- odour extraction unit with odour neutralisation through ceramic honeycomb filter
- optional odour extraction run-on function
- WhirlSpray shower technology with individual spray arm position
- optional spray arm oscillating function
- extendible Lady shower nozzle integrated into the spray nozzle with individual spray arm position
- automatic shower arm cleaning before and after each shower procedure
- optional dryer functionality via dryer opening

Comfort functions:

- confirmation sound when programming the shower toilet functions
- adjustable spray intensity and spray arm position
- WC seat with user recognition and WC seat heating
- WC seat and WC lid with SoftClosing
- main functions can be operated via a lateral ergonomic control panel
- can be operated entirely via remote control
- four individual user profiles and a basic profile can be stored

Cleaning and care:

- removable WC lid
- WC enhancement solution can be raised to clean between device and ceramic sanitary appliance
- descaling programme

## The device at a glance

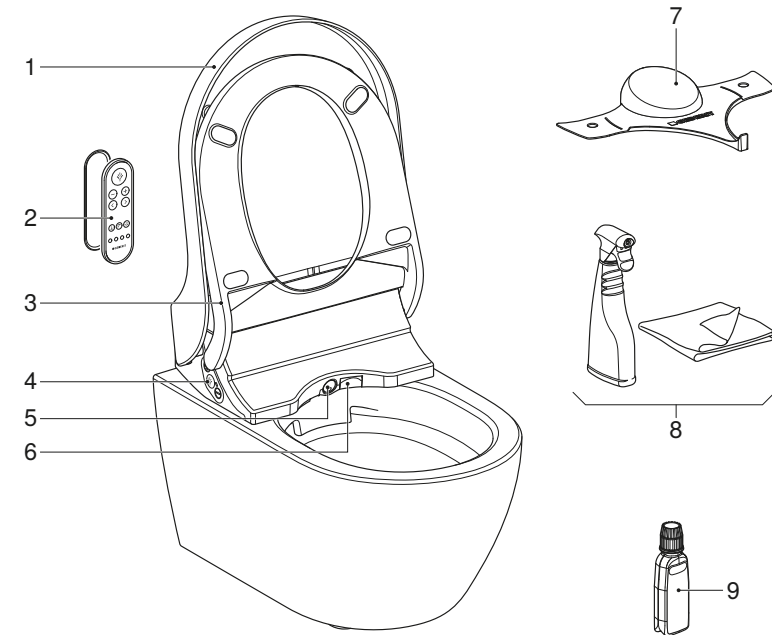

- 1 WC lid
- 2 Remote control with magnetic wall-mounted holder
- 3 WC seat ring with user recognition and WC seat ring heating
- 4 Lateral control panel with status LED
- 5 Spray arm with spray nozzle and Lady shower nozzle
- 6 Dryer flap
- 7 Spray shield
- 8 Geberit AquaClean cleaning set (art. no. 242.547.00.1)
- 9 Geberit AquaClean descaling agent (art. no. 147.040.00.1)

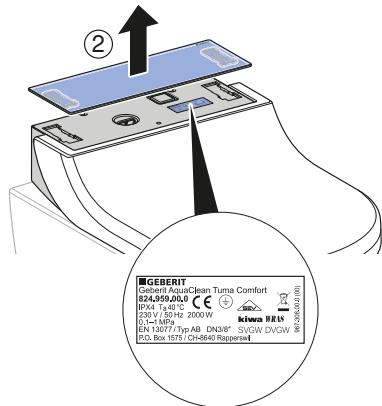
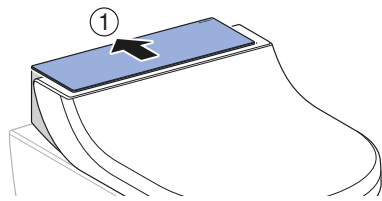

**GEBERIT**  
 Geberit AquaClean Tuma Comfort  
 624.959.00.0  
 0204, 14-01 °C  
 230 V / 50 Hz 2000 W  
 0.1-1.0 MPa  
 Ktwa 8818  
 EN 13077 Typ AB DNS8® SVEW DVGW  
 P.O. Box 1072, CH-2600 Rapperswil  
 80 20 60 000

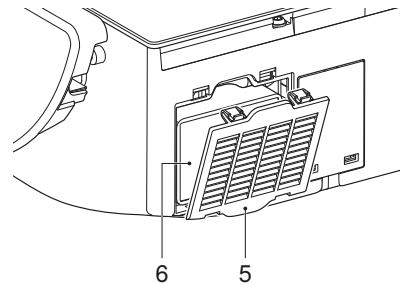
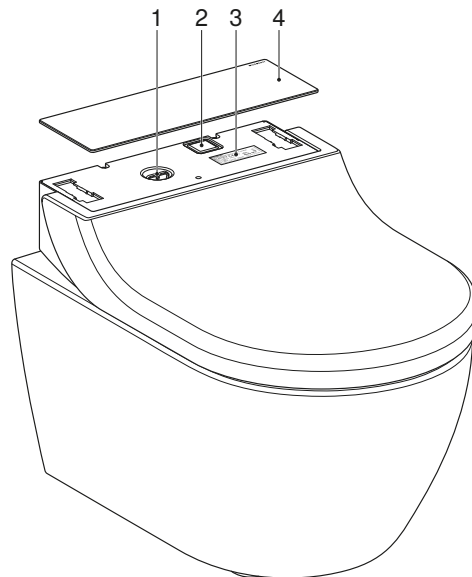

- 1 Filling opening with plug for Geberit AquaClean descaling agent
- 2 Power switch
- 3 Specification plate with serial number
- 4 Design cover
- 5 Filter compartment cover
- 6 Replaceable Geberit ceramic honeycomb filter, type 3

## Operating concept

### About the operating concept

The shower toilet can be operated via remote control, the lateral control panel on the shower toilet and the Geberit AquaClean app.

### Front side of the remote control

All functions for daily use can be operated from the front side of the remote control.

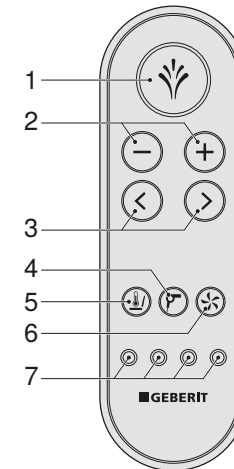

- 1 <Shower> button: Start and stop the spray functionality / stop dryer functionality.
- 2 <->/<+> buttons: Decrease or increase the spray intensity.
- 3 <left>/<right> arrow keys: Set the spray arm position.
- 4 <Dryer> button: Start and stop the dryer.
- 5 <WC seat ring heating> button: Switch WC seat ring heating on/off.
- 6 <Odour extraction> button: Start and stop odour extraction.
- 7 <User profile> buttons: Activate the user profiles 1–4.

### Rear side of the remote control

The battery compartment is located on the rear of the remote control.

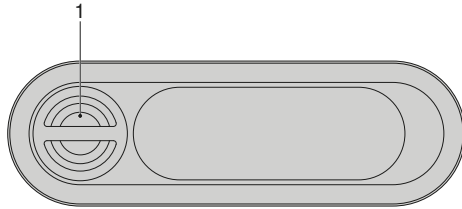

1 Battery compartment

### Lateral control panel

The shower toilet functions of the device can be operated from the lateral control panel.

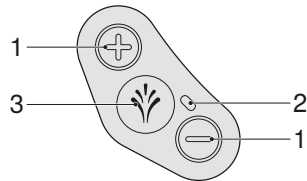

- 1 <+>/<-> buttons: Increase or decrease the spray intensity.
- 2 Status LED
- 3 <Shower> button: Start or stop the anal shower or the Lady shower.

### Status LED on the lateral control panel

The status LED on the lateral control panel informs you of the current device status.

LED	Description
Flashes blue	The device initialises after switching on. A system flush is performed.
Lights up blue	A user was recognised and water heating is activated in the basic settings. The LED switches off in economy mode.
Does not light up (no user)	Economy mode is active or the device is switched off.
Does not light up (during use)	Water heating and WC seat ring heating were deactivated in the basic settings.
Lights up green	The ceramic honeycomb filter must be replaced. → See "Replace the ceramic honeycomb filter", page 38.
Flashes blue-red	The device must be descaled. → See "Descale the device", page 40.
Flashes red	Malfunction message → See "The shower toilet is without function", page 44.
Flashes blue-red and lights up orange	The device is blocked and urgently needs to be descaled. The spray functionalities cannot be used when blocked. The block can be reset for 1 shower cycle. To implement this, the <Shower> button must be pressed for 5 seconds.
Lights up orange	The device is now descaling. It is not possible to use the shower toilet for the duration of the descaling procedure.
Flashes orange	Water replacement is being carried out. → See "Automatic water replacement", page 33.
Flashes red and orange at the same time	The descaling function has failed and is waiting for a command from the user.



## Geberit AquaClean app

The following shower toilet functions can be executed via the Geberit AquaClean app:

- Remotely controlling the Geberit AquaClean shower toilet.
- Displaying and adjusting the settings.

The Geberit AquaClean app offers the following additional benefits:

- Saving your personal settings on your smartphone.
- Support for care and maintenance of the device.
- Easy registration of your Geberit AquaClean shower toilet.
- Availability of user manuals.
- Availability of functionality videos.
- Availability of service and contact information.

The Geberit AquaClean app is available free of charge for Android and iOS smartphones in the respective App Store.

Android:



iOS:



 The range of functions offered by the Geberit AquaClean app may vary from country to country.

## Special assignment of the buttons

You can access advanced functions of your shower toilet using specially assigned buttons.

Table 1: Remote control

Function	Button on the remote control	On	Off
Start the Lady shower	Press the <Shower> button for 2 seconds.	–	–
Save basic profile	Press <User profile 1> and <User profile 2> at the same time for 2 seconds.	Beep (1x)	–
Save user profile	Press the desired <User profile> button for 2 seconds.	Beep (1x)	–
Switch oscillating motion of the spray arm on and off	Briefly press <left> and <right> at the same time.	–	–
Extend spray arm for cleaning	Briefly press <+> and <Shower> at the same time.	–	–
Re-assign remote control	Press <+> on the remote control and lateral control panel at the same time for 10 seconds.	Beep (1x)	–
Switch water heating on and off	Press <+> and <WC seat ring heating> at the same time for 2 seconds.	Beep (1x)	Beep (2x)
Set the odour extraction run-on function	Press <Odour extraction> for 2 seconds.	Beep (1x)	Beep (2x)
Confirm the filter replacement	Press <Odour extraction> and <Shower> for at least 2 seconds.	Beep (1x)	–
Reset to factory settings	Press <User profile 1> and <User profile 4> at the same time for 2 seconds.	Beep (3x)	–

Table 2: Lateral control panel

Function	Button on the lateral control panel	On	Off
Start the Lady shower	Press the <Shower> button for 2 seconds.	–	–
Extend spray arm for cleaning	Briefly press <+> and <Shower> at the same time.	–	–
Re-assign remote control	Press <+> on the remote control and lateral control panel at the same time for 10 seconds.	Beep (1x)	–
Start descaling function	Press <-> and <Shower> at the same time for 5 seconds.	–	–
Suppress the descaling message for 1 more shower cycle	Press the <Shower> button for 5 seconds.	Beep (1x)	–
Switch demonstration mode on/off	Press <+> and <-> at the same time for 5 seconds.	Beep (1x)	Beep (2x)

**Switching the device on and off**

**i** Wait at least 30 seconds between the switch-off and switch-on procedures.

**1** Lift the WC lid.

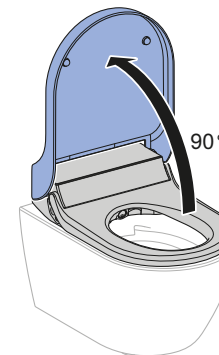

**2** Remove the WC lid.

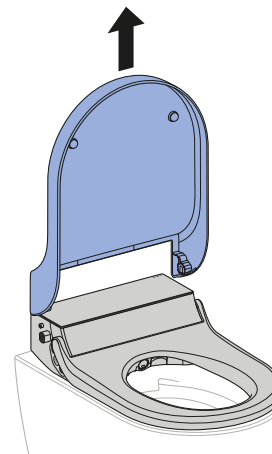

**3** Remove the design cover.

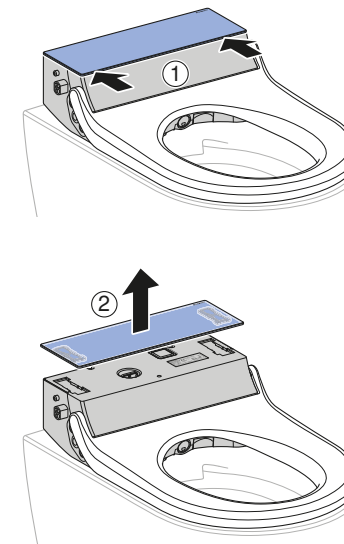

**4** Press the power switch.

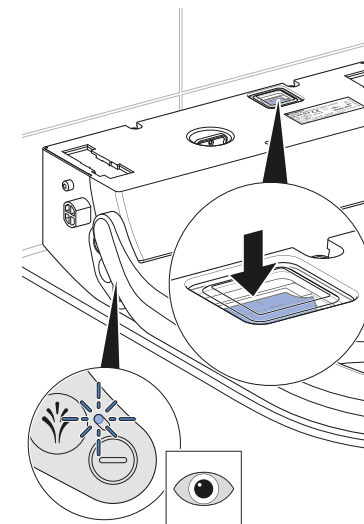

✓ The status LED on the lateral control panel flashes/goes out.

**5** Mount the design cover.

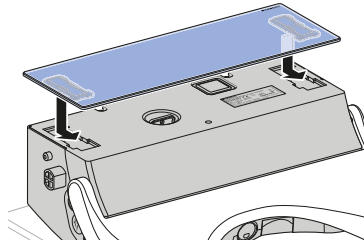

**6** Mount the WC lid.

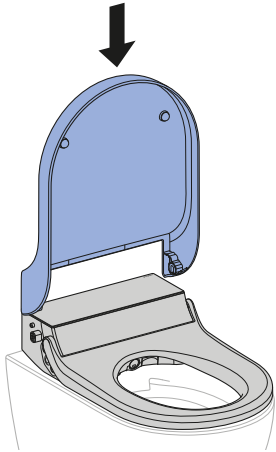

**7** Close the WC lid.



**Result**

✓ The device initialises again after switching on.

**How to use the device**

**Getting started**

- i** The functions can be deactivated, activated or adjusted via the remote control or the Geberit AquaClean app.
- The device beeps (1x) when a function is activated.
  - The device beeps (2x) when a function is deactivated.

When using the device, the following functions should take place.

When you sit down on the WC seat ring,

- user recognition is activated and the device enables the spray functionality.
- the WC seat ring heating starts.
- the odour extraction unit starts.

When you start the shower procedure,

- the anal shower runs for 50 seconds or the Lady shower runs for 30 seconds.
- the shower procedure can be interrupted at any time.
- the shower procedure can be adapted to your personal requirements.
- the dryer functionality runs for 5 minutes as soon as the anal shower or Lady shower has finished.
- the dryer functionality can be interrupted at any time.
- you can change the basic settings and adapt these to your personal requirements.
- you can save your personal basic profile as well as user profiles for the next use.

When you get up from the WC seat ring,

- the spray functionality deactivates.
- the dryer functionality deactivates.
- the WC seat ring heating deactivates.
- the odour extraction unit deactivates.
- the spray nozzle and Lady shower nozzle are rinsed thoroughly.
- the device is set to economy mode.

## Switch functions on or off permanently

If no personal settings have been made, the basic profile involving the factory settings is called up when using the shower toilet. Your personal basic profiles and user profiles can be reset to factory settings at any time. → See "Special assignment of the buttons", page 17.

Functions can be switched on or off permanently, which involves

- changing the basic profile and saving the personal settings that are called up automatically when using the shower toilet. → See "Change basic profile", page 29.
- creating up to four different user profiles and saving these to the respective user profile buttons as required. → See "Save user profiles", page 29.
- one of the saved user profiles being called up while using the shower toilet. → See "Calling up user profiles", page 30.

Overview of functions and setting options:

- Your device settings, → see "Your device settings", page 23
- Additional settings for your device, → see "Additional device settings in the Geberit AquaClean app", page 23

## Your device settings



If a user is recognised, the basic profile is activated automatically with the basic settings.

During the shower procedure, you can adjust the shower procedure to your personal needs at any time. You can assign your individual settings to one of the four user profile buttons and specifically retrieve them from the next use.

Setting	Adjustment range	Factory setting of basic profile
Spray intensity of the anal shower	level 1–5	level 3
Spray intensity of the Lady shower	level 1–5	level 1
Spray arm position of the anal shower	level 1–5	level 3
Spray arm position of the Lady shower	level 1–5	level 4
Oscillating function of the spray arm on the anal shower	on/off	on
Oscillating function of the spray arm on the Lady shower	on/off	off
Hot water of the spray functionality	on/off	on
WC seat ring heating	on/off	on
Dryer functionality following shower procedure	on/off	on
Odour extraction function with user recognition	on/off	on
Odour extraction run-on function	on/off	off

## Additional device settings in the Geberit AquaClean app

Setting	Adjustment range	Factory setting of basic profile
Shower water temperature	level 1–5	level 4
Dryer temperature	level 1–5	level 5
WC seat ring heating temperature	level 1–5	level 4
Water hardness	soft/medium/hard	hard

## Use the anal shower

### Prerequisite

- You are sitting down on the WC seat ring.

- ▶ Briefly press the <Shower> button on the lateral control panel or on the remote control once.

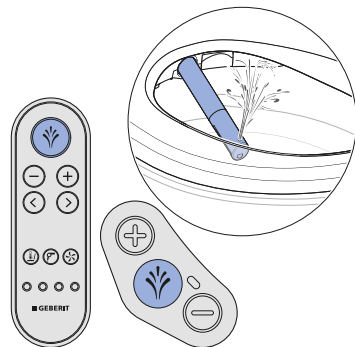

### Result

- ✓ The shower procedure starts.
- ✓ The anal shower starts in oscillating function. A small amount of water drains into the WC ceramic appliance via the overflow. The anal shower is active for 50seconds.

- i** You can stop the shower procedure early by pressing the <Shower> button once again.

## Adjusting the shower procedure to your personal needs

### Switching the oscillating motion of the anal shower on and off

- i** The oscillating motion of the spray arm increases the cleaning effect.

### Prerequisite

- The shower procedure is running.

- ▶ Press the <left> and <right> arrow keys at the same time to switch the oscillating motion off and on during the shower procedure.

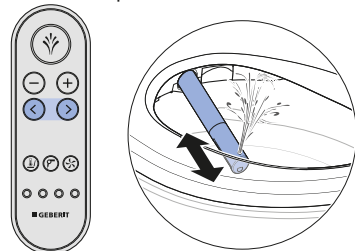

## Use the Lady shower

- i** The woman's intimate area is a very sensitive zone and requires special and prudent care. The Lady shower must be set to your ergonomic conditions to achieve an optimal cleaning result. The position of the spray nozzle and the spray intensity must be selected so that the shower spray cannot penetrate the vagina.

### Prerequisite

- You are sitting down on the WC seat ring.

- ▶ Press the <Shower> button on the lateral control panel or on the remote control for 2 seconds.

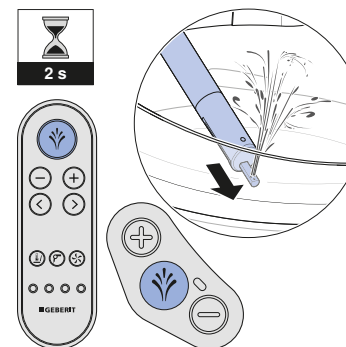

### Result

- ✓ The Lady shower starts.

- i** You can stop the shower procedure early by pressing the <Shower> button once again.

## Switching the oscillating motion of the Lady shower on and off

- i** In certain cases, using the oscillating motion of the spray arm with Lady shower function can cause germs to be spread from the anal area.

### Prerequisite

- The Lady shower is running.

- ▶ Press the <left> and <right> arrow keys at the same time to switch the oscillating motion off and on during the Lady shower procedure.

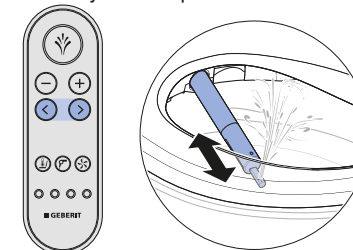

## Switch dryer on and off

**i** The drying procedure starts automatically according to the factory settings as soon as the shower procedure has finished. The automatic drying procedure can be switched off and started manually.

### Prerequisite

- You would like to start a drying procedure manually.

▶ Press the <Dryer> button.

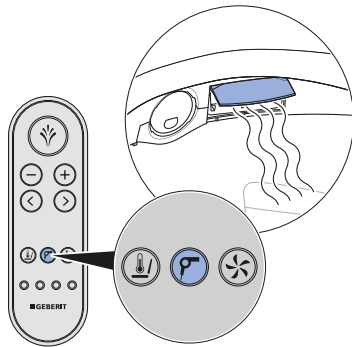

### Result

- ✓ The drying procedure starts and runs for 5 minutes.

**i** You can stop the drying procedure early by pressing the <Dryer> button once again.

## Switch off WC seat ring heating

**i** WC seat ring heating is switched on according to the factory settings. WC seat ring heating can be switched off and switched on manually.

### Prerequisite

- You are sitting down on the WC seat ring.

▶ Briefly press the <WC seat ring heating> button on the remote control.



### Result

- ✓ WC seat ring heating is switched off.

**i** Press the <WC seat ring heating> button again to switch WC seat ring heating back on.

**i** It takes some time for a fully heated WC seat ring to cool down to the ambient temperature again.

## Switch odour extraction run-on function on and off

### Prerequisite

- You are sitting down on the WC seat ring.

▶ Press the <Odour extraction> button on the remote control for 2 seconds.

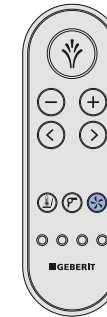

### Result

- ✓ The device beeps (1x).
- ✓ The odour extraction run-on function is activated. The run-on time is 2 minutes and starts at the end of the final spray or dryer functionality.

**i** By pressing the button again for 2 seconds, you can deactivate the function again. The device beeps (2x).

## Switch continuous flow heater off and on

### Prerequisite

- You are sitting down on the WC seat ring.

▶ Press the <WC seat ring heating> and <+> buttons on the remote control at the same time for 2 seconds.

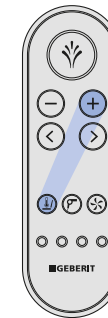

### Result

- ✓ The device beeps (2x). The continuous flow heater is switched off.
- ✓ The shower procedure is performed with cold water.

**i** By pressing the buttons again for 2 seconds, you can reactivate the function. The device beeps (1x).

## Adjusting the shower procedure to your personal needs

### Set the spray intensity

**Prerequisite**

- The shower procedure is running.

- ▶ Press the <+> button to increase the spray intensity. Press the <-> button to decrease the spray intensity.

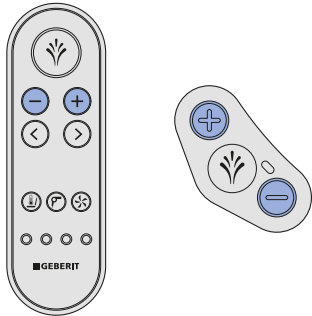

**Result**

- ✓ The shower spray becomes stronger/weaker.

- i** You can set the spray intensity in 5 stages.

### Set the spray arm position

- i** Female users should set the spray arm position of the spray functionality to their ergonomic conditions so that it does not compromise the natural protection of the vaginal area.

**Prerequisite**

- The shower procedure is running.

- ▶ Press the arrow keys on the remote control to position the spray arm.

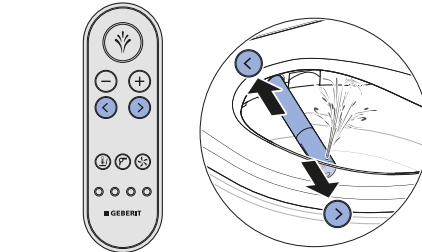

**Result**

- ✓ The spray arm is optimally positioned.

- i** You can set the spray arm position in 5 stages.

### Change basic profile

**Prerequisite**

- You are sitting down on the WC seat ring.
- You have adjusted the shower procedure to suit your personal requirements.

- ▶ Press the first two <User profile buttons> at the same time for more than 2 seconds during the drying procedure or at the end of the shower procedure.

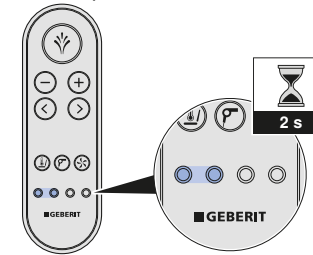

**Result**

- ✓ The device beeps (1x).
- ✓ Your personal basic profile is saved and is automatically called up when using the shower toilet.

### Save user profiles

**Prerequisite**

- You are sitting down on the WC seat ring.
- You have adjusted the shower procedure to suit your personal requirements.

- ▶ Press one of the four user profile buttons for more than 2 seconds during the drying procedure or at the end of the shower procedure.

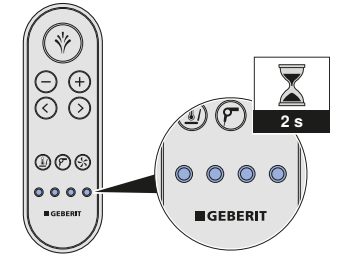

**Result**

- ✓ The device beeps (1x).
- ✓ Your personal user profile is saved to the selected <User profile button>.

## Calling up user profiles

**i** User profiles allow you to access your personal settings directly. Select your user profile as soon as you sit down.

### Prerequisite

- Personal user profiles are saved to the <User profile> buttons. → See "Save user profiles", page 29.

▶ Press the <User profile> button on which your personal settings are stored.

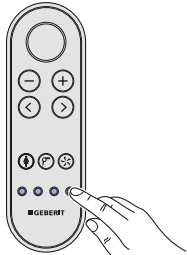

### Result

- ✓ Your personal user profile is called up and activated.

## Saving your personal user profile in the Geberit AquaClean app

**i** As long as you are in the detection range of the shower toilet, you do not need to activate the user recognition in order to save your user profile in the Geberit AquaClean app.

### Prerequisite

- The current version of the Geberit AquaClean app is installed on your smartphone.
- The Geberit AquaClean app is running.
- You are in the detection range of the shower toilet.

▶ Save your settings in the Geberit AquaClean app.

### Result

- ✓ Your personal user profile is saved onto your smartphone.
- ✓ The settings apply to all connected shower toilets.

## Cleaning and descaling the device

### General cleaning recommendations

Cleaning the shower toilet at the recommended cleaning intervals will ensure that it functions properly. The shower toilet must only be cleaned using suitable cleaning agents and cleaning equipment. → See "Suitable cleaning agents and cleaning equipment", page 31.

Cleaning interval	Cleaning activity
Daily	<ul style="list-style-type: none"> <li>• Remove water drops with a soft, lint-free cloth to avoid limescale stains.</li> </ul>
Weekly	<ul style="list-style-type: none"> <li>• Clean all surfaces and corners thoroughly. → See "Cleaning the WC lid, WC seat ring and housing", page 35</li> <li>• Test spray nozzle and clean if required. → See "Clean the spray nozzle", page 37</li> </ul>
Monthly	<ul style="list-style-type: none"> <li>• Rinse the spray nozzle under running water to remove foreign substances.</li> <li>• Clean the WC ceramic appliance with Geberit AquaClean cleaning agent. → See "Cleaning the flushing area of the WC ceramic appliance", page 34</li> </ul>

### Suitable cleaning agents and cleaning equipment

#### ATTENTION

##### Aggressive descaling agents

Inappropriate descaling agents can damage the device.

- ▶ Only use Geberit AquaClean descaling agent for descaling.

#### ATTENTION

##### Aggressive and scouring cleaning agents





Cleaning using aggressive and scouring cleaning agents can cause surface damage.



- ▶ Use Geberit AquaClean cleaning agents.



Using the Geberit AquaClean cleaning set is recommended, as this set includes a ready-made cleaning agent that is ideal for cleaning all Geberit AquaClean surfaces.

Recommended properties of suitable cleaning agents and cleaning equipment for best cleaning results:

Symbol	Properties of suitable cleaning agents
	Skin-friendly
	Cleaning agents are permitted to have a low acid content, e.g. heavily diluted citric acid
	Low-foaming
	Liquid
	Water-dilutable

Symbol	Suitable cleaning equipment
	Soft, fine-pored sponges
	Lint-free, soft cloths which are free of dust
	Toilet brush

### Automatic water replacement

If the shower toilet has not been used for more than 2 weeks, the device is rinsed with fresh water after it is switched on. This ensures optimum shower water quality before usage.

### Targeted disinfection

Disinfection is only required if there is a definite risk of infection as a result of germs. Otherwise, keep to the recommended cleaning intervals and carry out the specified cleaning activities. → See General cleaning recommendations.

### ATTENTION

#### Aggressive disinfectants

Disinfection using aggressive disinfectants can cause surface damage.

- ▶ Only use alcohol-based disinfectants that are also suitable for hand and skin disinfection.
- ▶ Observe the safety notes from the manufacturer when handling hazardous substances.

Type of disinfection	Disinfection procedure
<b>Wet wipe disinfection</b> For use on smooth surfaces that can be rubbed	<ul style="list-style-type: none"> <li>▶ Moisten all surfaces with disinfectant.</li> <li>▶ Allow the disinfectant to take effect according to the manufacturer information.</li> <li>▶ Then rub the surfaces with single-use towels.</li> </ul>

### Caring for and cleaning smooth surfaces

All smooth surfaces can be cleaned hygienically with water and a mild, liquid cleaning agent that is kind to the skin.

 Aggressive and scouring cleaning agents can damage the surface. Only use mild, liquid cleaning agents that are kind to the skin. The Geberit AquaClean cleaning set (art. no. 242.547.00.1) includes a ready-made cleaning agent that is optimal for cleaning all Geberit AquaClean surfaces.

### Cleaning coated WC ceramic appliances

The WC ceramic appliance has a special coating. This coating draws water drops together to form spheres which drip away very effectively. Residue such as limescale and dirt is taken up by the water drops and simply flushed away with them. This effect is very environmentally friendly, as no aggressive WC cleaning agents are required.

### Cleaning the flushing area of the WC ceramic appliance

- 1** Spray the WC ceramic appliance with Geberit AquaClean cleaning agent and allow the cleaning agent a few minutes to take effect.
- 2** Afterwards, rinse the WC ceramic appliance with water.
- 3** Remove stubborn stains with a toilet brush.

### Removing the WC lid

- 1** Lift the WC lid.

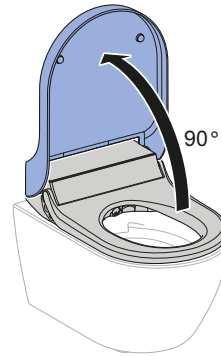

- 2** Remove the WC lid.

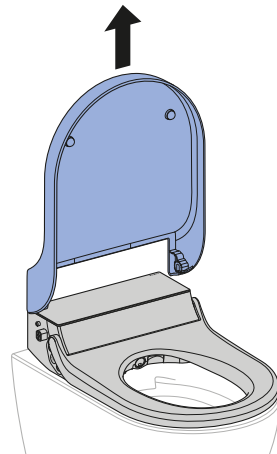

### Cleaning the WC lid, WC seat ring and housing

- i** Be careful not to scratch the surface of the WC seat. Always place the components on a soft, non-scratching underlay.

- 1** Spray the surfaces with Geberit AquaClean cleaning agent. Wipe the surfaces with a soft, lint-free, damp cloth.
- 2** Open the WC lid.

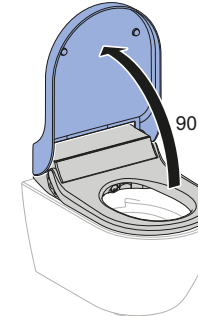

- 3** Remove the WC lid.

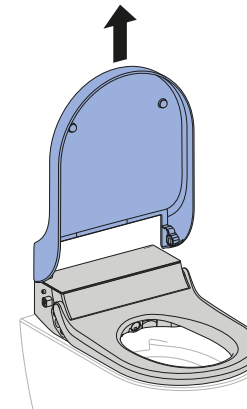

- 4** Remove the design cover for complete cleaning.

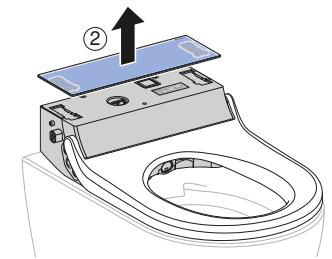
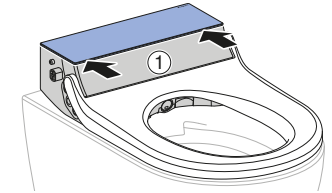

- 5** Spray the WC lid and the WC seat with Geberit AquaClean cleaning agent. Wipe the surfaces with a soft, lint-free, damp cloth.

- 6** Then dry all surfaces with a soft, lint-free cloth.

- 7** After cleaning is complete, re-assemble the device in reverse order of disassembly.

## Cleaning between the device and the WC ceramic appliance



### WARNING

**Danger of fatal electric shock**  
Water can flow into the device when it is moved without a removal limiter (safety line).

- ▶ Do not cut or damage the line of the removal limiter.
- ▶ Do not manipulate or remove the removal limiter.

**1** Switch off the device.

**2** Remove the device from the base plate.

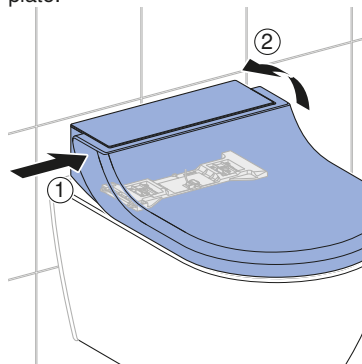

**3** Lift the device as far as the removal limiter permits. Clean the gap between the shower toilet and ceramic sanitary appliance.

**4** Mount the device on the base plate. Ensure that it is safely engaged.



**5** Switch on the device.

## Clean the spray nozzle



- For cleaning, use a soft, lint-free cloth.
- Geberit AquaClean cleaning agent is particularly suitable for all surfaces of the device.

**1** Lift up the WC lid and the WC seat ring.

**2** Press the <+> and <Shower> buttons at the same time.

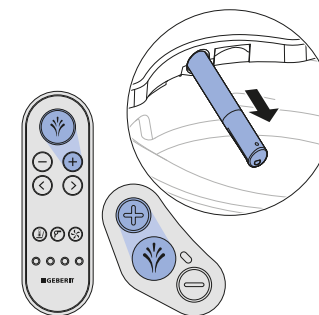

✓ The spray arm extends fully.

**3** Hold the spray arm firmly and remove the spray nozzle from the front to clean and descale it. Always ensure that the spray nozzle moves parallel to the spray arm.

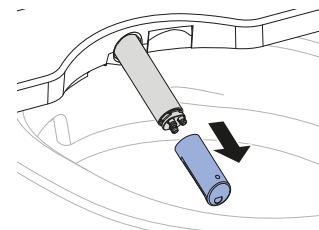

**4** Replace the spray nozzle if it can no longer be completely cleaned and descaled.

**5** Spray the spray arm with Geberit AquaClean cleaning agent. Then rinse it thoroughly with warm water.

**6** Dry the spray nozzle carefully.

**7** Mount the spray nozzle.

**8** Press the <Shower> button.

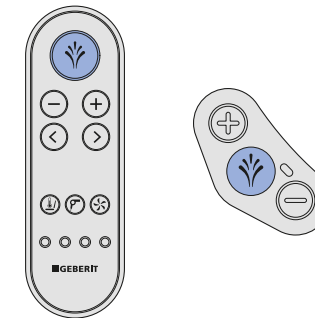

✓ The spray arm retracts fully. The cleaning procedure is now complete.

## Replace the ceramic honeycomb filter



### WARNING

#### Danger of fatal electric shock

Water can flow into the device when it is moved without a removal limiter (safety line).

- ▶ Do not cut or damage the line of the removal limiter.
- ▶ Do not manipulate or remove the removal limiter.



### CAUTION

#### Possible health hazard

Impurities in the filter could lead to contamination of the breathing air.

- ▶ Replace the filter annually.



The ceramic honeycomb filter is located on the right rear side of the device below a cover. It is fastened with 2 catch springs.

#### Prerequisite

- The status LED lights up green.

- 1** Remove the device from the base plate.

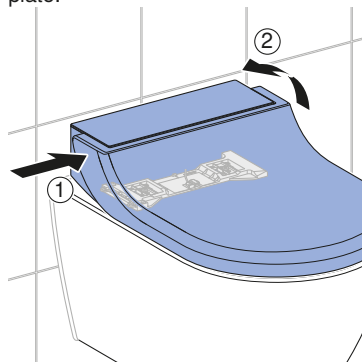

- 2** Turn the device a little in a clockwise direction until you have access to the filter cover.

- 3** Bend the catch springs of the filter cover slightly downwards and open the cover.

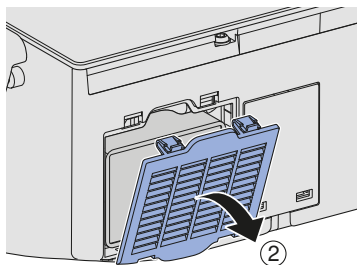
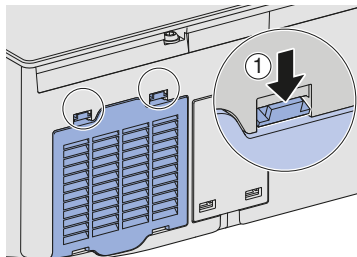

- 4** Remove the used filter from the opening. Then insert the new filter.

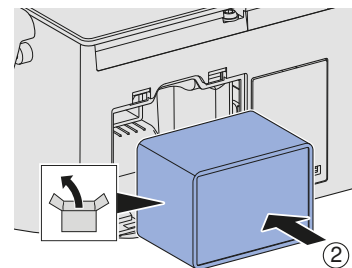
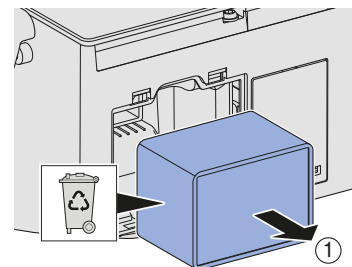

- 5** Close the cover again.

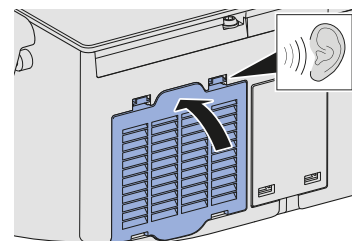

- 6** Mount the device on the base plate. Ensure that it is safely engaged.

- 7** Press the <Odour extraction>button and the <Shower> button at the same time and hold for at least 2 seconds.



#### Result

- ✓ The device beeps (1x). The counter is reset.
- ✓ Odour neutralisation begins to function again as soon as the status LED has gone out.

## Descal the device

### ATTENTION

#### Aggressive descaling agents

Inappropriate descaling agents can damage the device.

- ▶ Only use Geberit AquaClean descaling agent for descaling.

- i** You will need to descale the device at least once a year, or more often depending on the number of shower cycles.
- During the descaling procedure, you can continue to use the WC without the spray functionalities.
- The descaling procedure lasts up to 30 minutes. Once the orange LED switches off, the spray functionality is once again ready for operation.
- Remove splashes of Geberit AquaClean descaling agent immediately with a damp cloth.

#### Prerequisite

- The status LED on the control panel flashes blue-red or it lights up orange and flashes blue-red at the same time.
- The WC lid is removed.

**1** Open the design cover.

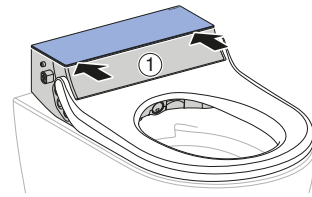

**2** Remove the plug.

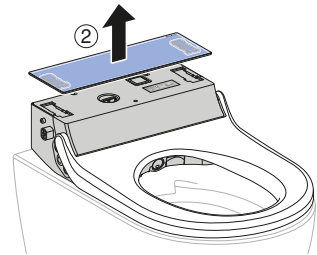

**3** Press and hold the <-> and <Shower> buttons at the same time for more than 5 seconds on the lateral control panel.

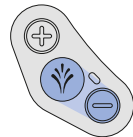
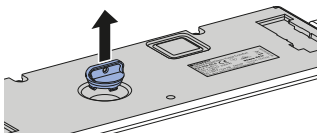

- ✓ The status LED on the lateral control panel flashes orange and red at the same time.

**4** Pour around half a bottle of Geberit AquaClean descaling agent into the device.

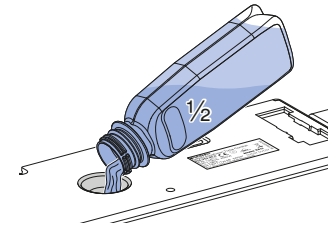

**5** Press the <Shower> button on the lateral control panel.  
 ✓ The status LED lights up orange.  
 ✓ The device processes the descaling agent and a small quantity runs into the ceramic appliance. After around 15 seconds, the LED flashes orange and red on the lateral control panel at the same time.

**6** Pour the remainder of the Geberit AquaClean descaling agent into the device.

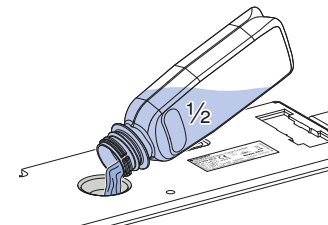

**7** Re-insert the plug.

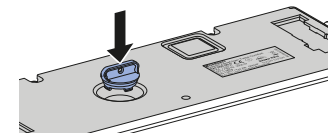

**8** Close the design cover.

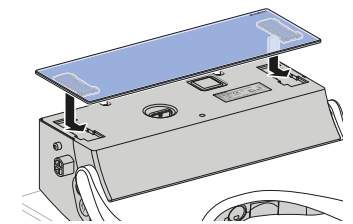

**9** Mount the WC lid.

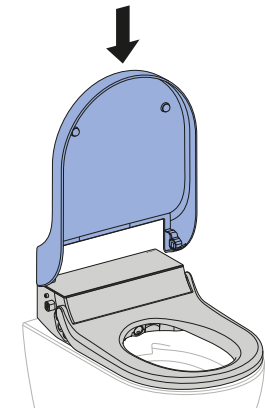

**10** Press the <Shower> button on the lateral control panel.



- ✓ The status LED lights up orange until the descaling programme is complete. Once the status LED switches off, the device is once again ready for operation.

## Device descaling message

The device can be configured for the local water hardness in accordance with the following table via the Geberit AquaClean app. This adaptation prevents unnecessary descaling procedures and helps protect the environment. Nevertheless, regular descaling of the device is required.

Area	°fH	°dH	°eH
soft	≤ 15	≤ 8	≤ 11
medium	15–25	8–14	11–18
hard	> 25	> 14	> 18

The following table helps you to identify descaling messages and to carry out the necessary fault clearance for each message.

Cause	Message	Fault clearance
Regular descaling: at least once a year	<ul style="list-style-type: none"> <li>The status LED on the control panel flashes blue-red.</li> <li>The Geberit AquaClean app displays a descaling message.</li> </ul>	<ul style="list-style-type: none"> <li>Perform descaling. → See Descaling the device.</li> </ul>
Locked device: multiple rejected descaling requests	<ul style="list-style-type: none"> <li>The status LED on the control panel lights up orange and flashes blue-red at the same time.</li> <li>The Geberit AquaClean app displays a descaling message.</li> </ul>	<p><b>Prerequisite</b></p> <ul style="list-style-type: none"> <li>A shower procedure is no longer possible without descaling.</li> <li>Perform descaling. → See Descaling the device.</li> </ul>

## Troubleshooting

### Troubleshooting

The table below explains what you need to do in the event of a fault:

- Carry out the steps one after the other until the device is no longer demonstrating any faults or is working as normal again.
- Be sure to follow the steps in order.

Step	Description of problem	Fault clearance
1	The shower toilet is demonstrating a fault or is not working as normal.	<ul style="list-style-type: none"> <li>Switch off the device. → See "Switching the device on and off", page 19.</li> <li>Wait 30 seconds.</li> <li>Switch on the device. → See "Switching the device on and off", page 19.</li> </ul>
2	Step 1 has been carried out. The shower toilet continues to demonstrate a fault or still does not work as normal.	<ul style="list-style-type: none"> <li>Test the status LED on the lateral control panel. → See "Status LED on the lateral control panel", page 15.</li> </ul>
3	Steps 1 and 2 have been carried out. The shower toilet continues to demonstrate a fault or still does not work as normal.	<ul style="list-style-type: none"> <li>Check the problem descriptions in the faults table and carry out the relevant fault clearance as required. → See "The shower toilet is without function", page 44 and "Other functional errors", page 45.</li> </ul>
4	Steps 1 to 3 have been carried out. The shower toilet continues to demonstrate a fault or still does not work as normal.	<ul style="list-style-type: none"> <li>contact customer service.</li> </ul>

## The shower toilet is without function

The following table will help you with troubleshooting if the shower toilet is without function.



### DANGER

#### Electric shock

Incorrect maintenance work or troubleshooting can lead to serious injury or death.

- ▶ In case of malfunctions, the device must immediately be switched off at the power switch and the customer service must be contacted.
- ▶ Only trained electrically skilled persons are permitted to perform electrical installations on the device.
- ▶ Only trained professionals are permitted to perform retrofitting on the device.



The shower toilet can be used as a normal toilet even in the event of a malfunction. The spray arm must be fully retracted. You start the toilet flush as usual by pressing the actuator buttons.

Description of problem	Cause	Fault clearance
The fuse or residual-current device in the electrical distributor trips once.	Malfunction has occurred	<ul style="list-style-type: none"> <li>▶ Replace or reset the fuse in the electrical distributor.</li> <li>▶ Reset the residual-current device in the electrical distributor.</li> </ul> <p><b>Result</b></p> <ul style="list-style-type: none"> <li>✓ The device initialises again after switching on. Using the device does not trip any fuses or residual-current devices.</li> </ul>
The fuse or residual-current device in the electrical distributor trips repeatedly when the device is used.	Device defective	<ul style="list-style-type: none"> <li>▶ Replace or reset the fuse or residual-current device in the electrical distributor.</li> <li>▶ Disconnect the mains plug (if available).</li> <li>▶ contact customer service.</li> </ul>
The product has an unknown technical defect.	Malfunction has occurred	<ul style="list-style-type: none"> <li>▶ Trip the fuse or residual-current device in the electrical distributor.</li> <li>▶ Disconnect the mains plug (if available).</li> <li>▶ contact customer service.</li> <li>▶ Have the power supply tested by a skilled person.</li> </ul>

## Other functional errors

The following table will help you with troubleshooting if individual functions of the shower toilet have failed.



The shower toilet can be used as a normal toilet even in the event of a malfunction. The spray arm must be fully retracted. You start the toilet flush as usual by pressing the actuator buttons.



If the device is defective, switch it off using the power switch.

Description of problem	Cause	Fault clearance
Odour neutralisation is weak or ineffective.	Ceramic honeycomb filter dirty	<ul style="list-style-type: none"> <li>▶ Replace the ceramic honeycomb filter. → See "Replace the ceramic honeycomb filter", page 38.</li> </ul>
The spray arm is not functioning correctly.	Malfunction has occurred	<ul style="list-style-type: none"> <li>▶ Switch off the device. → See "Switching the device on and off", page 19.</li> <li>▶ Wait 30 seconds.</li> <li>▶ Switch on the device. → See "Switching the device on and off", page 19.</li> </ul> <p><b>Result</b></p> <ul style="list-style-type: none"> <li>✓ The device initialises again after switching on.</li> </ul>
The cleaning effect of the shower has weakened.	Spray nozzles clogged or defective	<ul style="list-style-type: none"> <li>▶ Clean or replace the spray nozzles. → See "Clean the spray nozzle", page 37.</li> <li>▶ descale the device. → See "Descale the device", page 40.</li> </ul>
When using the shower function, the shower toilet no longer reaches the usual temperature.	Shower toilet dirty	<ul style="list-style-type: none"> <li>▶ descale the device. → See "Descale the device", page 40.</li> <li>▶ Switch off the device. → See "Switching the device on and off", page 19.</li> <li>▶ Wait 30 seconds.</li> <li>▶ Switch on the device. → See "Switching the device on and off", page 19.</li> </ul> <p><b>Result</b></p> <ul style="list-style-type: none"> <li>✓ The device initialises again after switching on.</li> </ul>

Description of problem	Cause	Fault clearance
The status LED flashes red.	Malfunction has occurred	<ul style="list-style-type: none"> <li>▶ Switch off the device. → See "Switching the device on and off", page 19.</li> <li>▶ Wait 30 seconds.</li> <li>▶ Switch on the device. → See "Switching the device on and off", page 19.</li> </ul> <p><b>Result</b></p> <ul style="list-style-type: none"> <li>✓ The device initialises again after switching on.</li> </ul>
	Reinitialisation unsuccessful	<ul style="list-style-type: none"> <li>▶ Contact customer service.</li> </ul>

### The remote control is without function

The following table will help you with troubleshooting if:

- the remote control is without function.
- the remote control is unable to control the shower toilet.



The remote control is inactive while the Geberit AquaClean app is in use.



Should the remote control fail to function, you can use the lateral control panel instead.



If the device is defective, switch it off using the power switch.

Description of problem	Cause	Fault clearance
The shower toilet can only be operated using the lateral control panel and not using the remote control.	Pairing unsuccessful	<ul style="list-style-type: none"> <li>▶ Re-assign the remote control. → See "Re-assign remote control", page 49</li> </ul> <p><b>Result</b></p> <ul style="list-style-type: none"> <li>✓ The device beeps (1x) and the blue LED on the lateral control panel lights up for 4 seconds.</li> </ul>
The remote control is unable to control the shower toilet. The remote control has been re-assigned.	Batteries flat	<ul style="list-style-type: none"> <li>▶ Replace battery (type CR2032). → See "Replace the remote control battery", page 48</li> </ul>
	Pairing unsuccessful	<ul style="list-style-type: none"> <li>▶ Re-assign the remote control. → See "Re-assign remote control", page 49</li> </ul>
The battery has been replaced and the remote control has been re-assigned. The shower toilet can only be operated using the lateral control panel and not using the remote control.	Remote control defective	<ul style="list-style-type: none"> <li>▶ contact customer service.</li> </ul>



## Replace the remote control battery

### Prerequisite

- During the entire procedure, the remote control must be located in the reception range of the shower toilet.

- 1 Remove the dead battery and dispose of it appropriately.

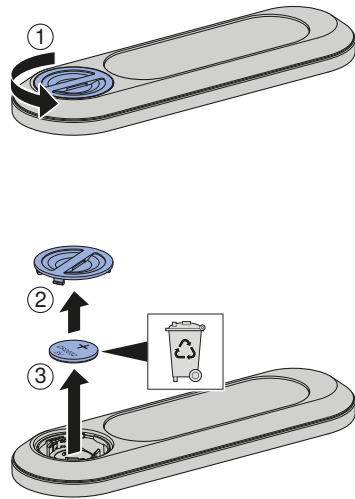

- 2 Insert a new CR2032 battery.

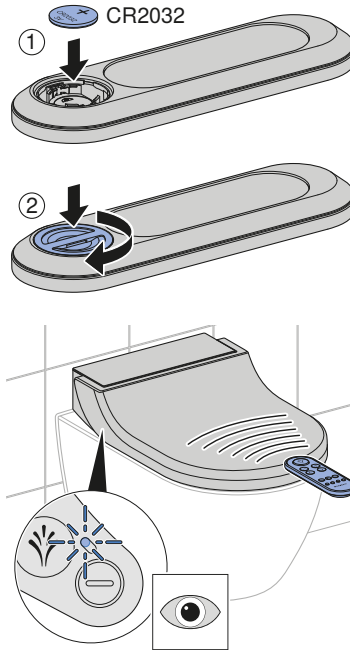

## Re-assign remote control

- i** The device can only be operated with a single, assigned remote control.

- ▶ Press the <+> button on the remote control and the <+> button on the lateral control panel for approx. 10 seconds.

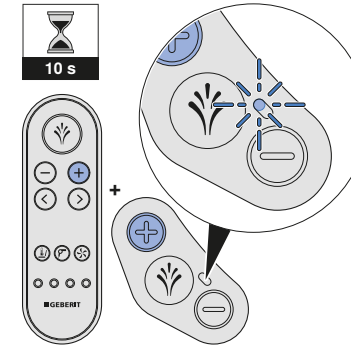

### Result

- ✓ The device beeps (1x) and the blue status LED on the lateral control panel lights up for 4 seconds.
- ✓ The shower toilet can be controlled by remote control.

## Sustainability

---

### Geberit Group and sustainability

As the European market leader in the sanitary industry, Geberit stands for water saving, resource efficiency and sustainable building. The Group has proven for decades that long-term business success is compatible with environmentally friendly actions and social policies. A company management geared to sustainability helps to save costs while minimizing risks at the same time. Geberit aims to act as a role model and set standards for its customers, suppliers and other partners. This means creating water-saving and sustainable products, using safe, environmentally friendly and resource-efficient production practices, engaging in purchasing and logistics activities with high environmental and ethical standards, and offering excellent working conditions for more than 12 000 dedicated and highly qualified employees worldwide. One way in which the company is showing its awareness of social responsibility is by participating in water relief projects around the world.

### Ecodesign – ecobalance

The basis for sustainable products is formed by a systematic innovation process in which product materials and functional principles are chosen that are as environmentally friendly as possible, risks are minimised and a high degree of resource efficiency is strived for. We can supply a detailed ecobalance for this product upon request.

### Tips for reducing the ecological footprint

This product was developed with the utmost care, also with regard to the consumption of energy, water and resources (see also technical data). You can reduce the ecological footprint of the product by observing the following recommendations:

- Switch off the device when you go on holiday.
- Interrupt the spray functionality manually in order to save hot water.
- Use small amounts of paper for drying.
- Switch off the heating function of the water heater when you do not need warm shower water.
- Use environmentally friendly cleaning agents.
- Carry out regular maintenance on the device and handle it with care in order to extend the service life.
- Return defective devices to Geberit or a designated partner for appropriate disposal.

## Disposal

---

### Disposal of old electrical and electronic equipment



In accordance with Directive 2012/19/EU (WEEE - Waste Electrical and Electronic Equipment) manufacturers of electrical equipment are obliged to take back old equipment and to dispose of it appropriately. The symbol indicates that the product cannot be disposed of with non-recyclable waste. Old equipment should be returned directly to Geberit where it will be disposed of appropriately. Addresses to which equipment can be returned can be requested from the relevant Geberit sales company.

## End user warranty

### End user warranty

The following end user warranty is provided in addition to and does not affect your contractual partner's liability for defective products.

The Geberit company ("Geberit") responsible for the place of installation of the Geberit AquaClean product ("product") shall provide the end user with a warranty for the product identified by the serial number on the warranty card. The scope of this warranty is as follows:

1. Geberit guarantees that the product shall be free from material defects and manufacturing faults for a period of 3 years ("warranty period") calculated from the installation date at the end user's premises. Warranty scope:
  - a) Within the first 2 years of the warranty period, a customer service representative authorised by Geberit shall rectify any material defects or manufacturing faults free of charge by repairing or replacing the defective parts.
  - b) In the third year of the warranty period, Geberit shall supply replacements for defective parts free of charge to the customer service representative authorised by Geberit and contracted by the end user to repair the product.
2. The end user shall not be entitled to assert more extensive claims against Geberit on the basis of this warranty.
3. Claims can only be made under the warranty if:
  - a) the product has been installed and put into operation by an installation company or by customer service personnel authorised by Geberit.
  - b) no modifications have been made to the product; in particular, no parts have been removed, replaced or added.
  - c) the product defect has not been caused by improper installation or use, nor can it be attributed to inadequate care or maintenance.
  - d) claims shall only be made during the third year of the warranty period if the end user has completed the enclosed warranty card in full and returned it to the Geberit company responsible for the place of installation within 90 working days of the installation date.
4. This warranty applies solely to places of installation in countries in which Geberit has its own sales company or is represented by a sales partner.
5. The warranty is exclusively subject to the substantive law of the country in which Geberit has its place of business. The United Nations Convention on Contracts for the International Sale of Goods is expressly excluded. The exclusive place of jurisdiction for all disputes arising from or in connection with this warranty is the location of Geberit's headquarters.



## Technical data and conformity

### Technical data

Nominal voltage	230 V AC
Mains frequency	50 Hz
Power consumption	2000 W
Power consumption standby	≤ 0.5 W
Protection degree	IPX4
Protection class	I
Frequency range	2400 MHz–2483.5 MHz
Maximum output power	0 dBm
Wireless technology	Bluetooth® Low Energy <sup>1)</sup>
Mains connection	Mains connection via system plug with flexible three-wire sheathed cable
Spray time	50 s
Number of shower pressure settings, shower spray	5
Water temperature	37 °C
Operating temperature	5–40 °C
Flow pressure	50–1000 kPa
	0.5–10 bar
Minimum flow pressure	0.5 bar
	50 kPa
Calculated flow rate	0.02 l/s
Maximum load, WC seat	150 kg

<sup>1)</sup> The Bluetooth® brand and its logos are the property of Bluetooth SIG, Inc. and are under licence by Geberit.

### Simplified EU Declaration of Conformity

Hereby, Geberit International AG, declares that the radio equipment type Geberit AquaClean Tuma is in compliance with Directive 2014/53/EU.

The full text of the EU declaration of conformity is available at the following internet address: <https://doc.geberit.com/969453000.pdf>.

**(CH) Geberit Vertriebs AG**

Schachenstrasse 77  
CH-8645 Jona  
T 0848 882 982  
www.geberit-aquaclean.ch

**(DE) Geberit Vertriebs GmbH**

Kundendienst/Serviceestelle  
Theuerbachstrasse 1  
D-88630 Pfullendorf  
T (075 52) 934 10 11  
F (075 52) 934 866  
www.geberit-aquaclean.de

**(AT) Geberit Vertriebs GmbH & Co. KG**

Geberitstrasse 1  
A-3140 Pottenbrunn / St. Pölten  
T +43 2742 401-400  
F +43 2742 401-50  
www.geberit-aquaclean.at

**(AE) Geberit International Sales AG**

Dubai Branch  
B702-B705  
Building No. 1  
Dubai Design District  
PO Box  
UAE-282317 Dubai  
T +971 4 204 5477  
F +971 4 204 5497  
www.geberit.ae

**(BE) Geberit nv**

Beaulieustraat 6  
B-1830 Machelen  
T +32 2 252 0111  
F +32 2 251 0867  
www.geberit-aquaclean.be

**(BG) Юнитрейд Интернешъъл ЕООД**

бул. "Черни връх" 161-A  
1407 София  
T 02/ 968 11 11  
F 02/ 968 10 01  
www.unitrade-bg.com

**(CN) 吉博力(上海)贸易有限公司**

地址: 上海市嘉定区南翔高科技  
园区惠平路1515号  
邮编: 201802

**(CZ) Geberit spol. s r.o.**

Sokolovská 2408/222  
190 00 Praha 9  
T +420 547 212 335  
F +420 547 212 340  
www.geberit.cz

**(DK) Geberit A/S**

Lægårdsvej 26  
DK-8520 Lystrup  
T +45 86 74 10 86  
F +45 86 74 10 98  
www.geberit-aquaclean.dk

**(ES) Geberit, S.A.U.**

Plaza Europa, 2-4, 6ª planta  
ES-08902 L'Hospitalet del Llobregat  
(Barcelona)  
T +34 902 170 635  
www.geberit-aquaclean.es

**(FI) Geberit Oy**

Tahkotie 1  
FI-01530 Vantaa  
P +358 9 867 8450  
www.geberit.fi

**(FR) Geberit France**

ZA du Bois Gasseau - CS40252  
Samoreau  
FR-77215 Avon Cedex  
Téléphone 01 60 71 66 61  
T +33(0)825 801 603  
F +33(0)825 801 604  
www.geberit-aquaclean.fr

**(GB) Geberit Sales Ltd.**

Geberit House  
Edgehill Drive  
Warwick  
CV34 6NH  
T (0)1926 516 800  
T (0)1926 516 809  
In Eire T +44 1622 717 811  
www.geberit-aquaclean.co.uk

**(HR) Predstavništvo Geberit**

prodaja d.o.o. Ruše  
Samoborska cesta 218  
10090 Zagreb, HR  
T +385 1 3867 800  
F +385 1 3867 801  
www.geberit.hr

**(HU) Geberit Kft**

1117 Budapest,  
Alíz utca 2.  
T +36 1 204 4187  
www.geberit.hu

**(IT) Geberit Marketing e Distribuzione SA**

Via Gerre 4  
CH-6928 Manno  
T +41 91 611 92 92  
F +41 91 611 93 93  
www.geberit-aquaclean.it

**(LU) Geberit Luxembourg**

61, avenue de la Libération  
L-3850 Schifflange  
T +352 54 52 26  
F +352 54 54 91  
www.geberit.lu

**(NL) Geberit B.V.**

Fultonbaan 15  
3439 NE Nieuwegein  
T +31 (0)3060 57700  
F +31 (0)3060 53392  
www.geberit-aquaclean.nl

**(NO) Geberit AS**

Luhrtoppen 2  
N-1470 Lørenskog  
T +47 67 97 82 00  
www.geberit-aquaclean.no

**(PL) Geberit Sp. z o.o.**

ul. Postępu 1  
02-676 Warszawa  
T +48 22 843 06 96  
www.geberit-aquaclean.pl

**(PT) Geberit Tecnologia Sanitária, S.A**

Rua Cupertino de Miranda, nº 12-2º A  
PT-1600-485 LISBOA  
www.geberit.pt

**(RO) Geberit International Sales AG**

Splaiul Unirii, Nr. 86, Et. 3  
Sector 4, Bucharest  
T +40 21 330 30 80/81  
F +40 21 330 31 61  
www.geberit.ro

**(RS) Geberit - Predstavništvo za**

Republiku Srbiju i Republiku Crnu Goru  
Vojvode Skopljanca 24  
SR-11000 Beograd  
T + 381 11 30 96 430  
F + 381 11 30 96 431  
www.geberit.rs

**(RU) ООО „ГЕБЕРИТ РУС“**

Олимпийский пр., 16, стр.5, 5 этаж  
129110 Москва  
тел.: +7 495 783 83 30  
www.geberit.ru

**(SE) Geberit AB**

Folketshusgatan 1  
Box 140  
295 22 Bromölla  
T +46 40 680 89 30  
www.geberit.se

**(SI) Geberit prodaja, d.o.o.**

Bezena 55  
2342 Ruše  
T 01 586 22 00  
F 01 586 22 19  
www.geberit.si

**(SK) Geberit Slovensko s.r.o.**

Karadžičova 10  
821 08 Bratislava 2  
T +421 2 49 20 30 71  
www.geberit.sk

**(TR) Geberit Tesisat Sistemleri Tic Ltd. ti.**

Içerenköy Mah. Engin Sok. No. 10,  
34752 Atasehir-Ystanbul, Turkey  
T +90 216 340 82 73  
F +90 216 340 82 79  
www.geberit.com.tr

**(ZA) Geberit Southern Africa (Pty.) Ltd.**

6 Meadowview Lane,  
Meadowview Business Estate,  
Longmeadow,  
Linbro Park  
Johannesburg,  
South Africa  
T +27 11 444 5070  
F +27 11 444 5992  
www.geberit.co.za

